

Name: _____ ()

Class: Primary 4 _____

Primary 4
Semestral Assessment 2 – 2016
SCIENCE
BOOKLET A
27 October 2016

Total Time for Booklets A and B: 1 hour 45 minutes

28 questions
56 marks

Do not open this booklet until you are told to do so.
Follow all instructions carefully.
Answer all questions.

This booklet consists of 21 printed pages.

Section A (28 x 2 marks = 56 marks)

For each question from 1 to 28, four options are given. One of them is the correct answer. Make your choice (1, 2, 3 or 4). Shade the correct oval (1, 2, 3 or 4) on the Optical Answer Sheet provided.

1. Which animal has a pupa as a stage in its life cycle?

- (1) frog
- (2) duck
- (3) beetle
- (4) grasshopper

2. Selina had four identical pots, A, B, C and D. She put two seeds into each pot and placed them under the conditions as shown in the table below.

Pot	Air	Light	Water	Temperature (°c)
A	yes	no	yes	32
B	no	yes	yes	32
C	yes	no	no	15
D	yes	yes	no	15

In which pot, A, B, C or D, will the seeds most likely germinate?

- (1) A
- (2) B
- (3) C
- (4) D

3. The diagram below shows parts of a plant.

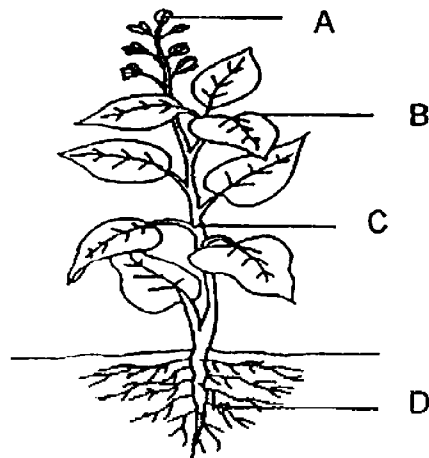

Which one of the following functions of the plant parts is correct?

	Make food	Support the plant
(1)	A	B
(2)	B	D
(3)	B	C
(4)	C	D

4. Study the classification chart below.

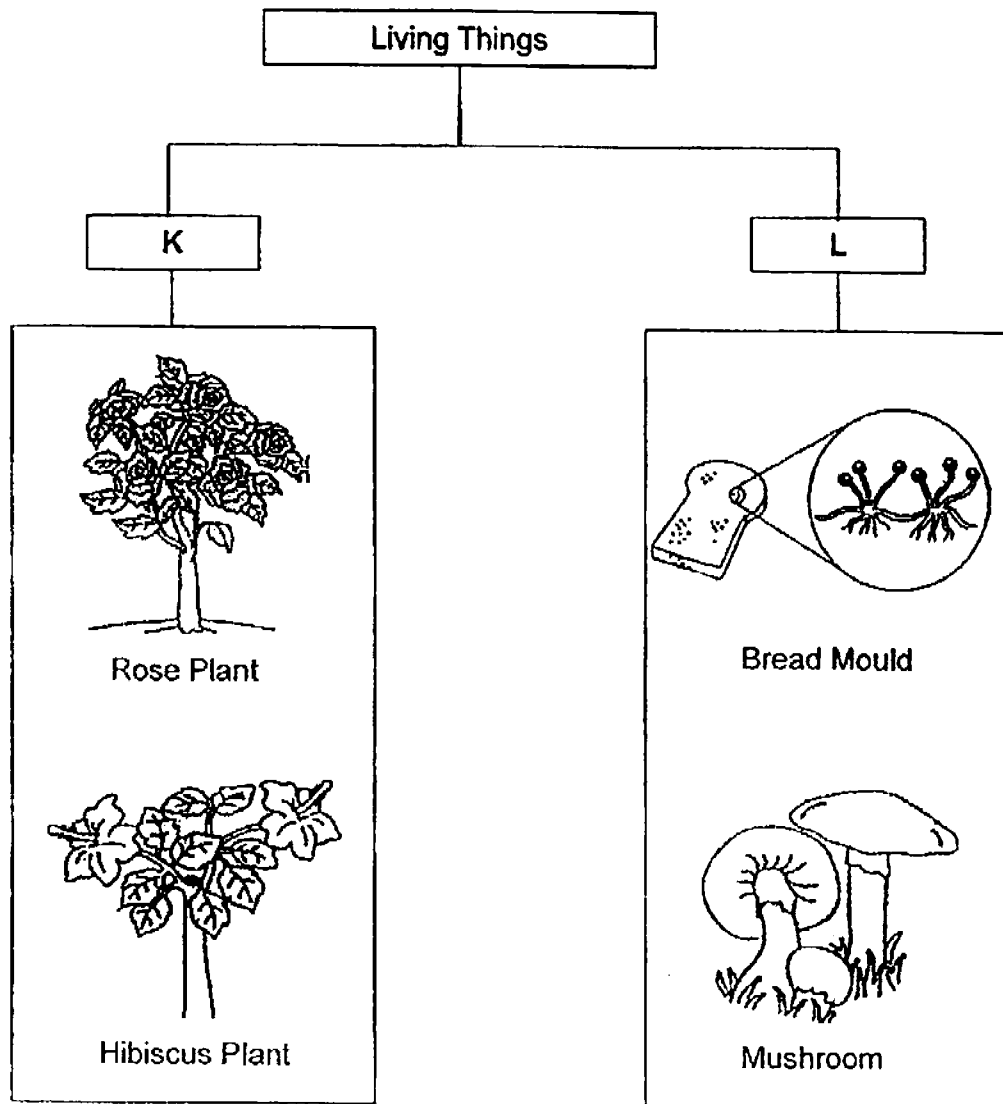

Which one of the following would be the most appropriate headings for K and L?

	K	L
(1)	Flowering Plant	Fungi
(2)	Flowering plant	Bacteria
(3)	Non-flowering plant	Bacteria
(4)	Non-flowering plant	Flowering plant

5. While clearing her cupboard, Charmaine discovered that her leather handbag was covered with grey powdery patches as shown in the diagram below.

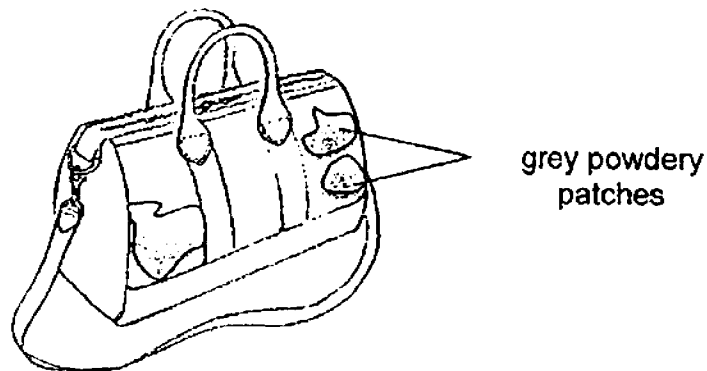

Her mother said that the small grey patches were mould.

Condition	Cupboard			
	E	F	G	H
Presence of oxygen	✓	✓	X	✓
Presence of water	X	✓	✓	X
Temperature in the Cupboard	80°C	27°C	26°C	10°C

Based on the table above, in which of the following cupboard(s), E, F, G or H, did Charmaine place her leather handbag?

- (1) E only
- (2) F only
- (3) F and G only
- (4) E and H only

6. Liping conducted an experiment using the set ups shown below and left them in the classroom for a week.

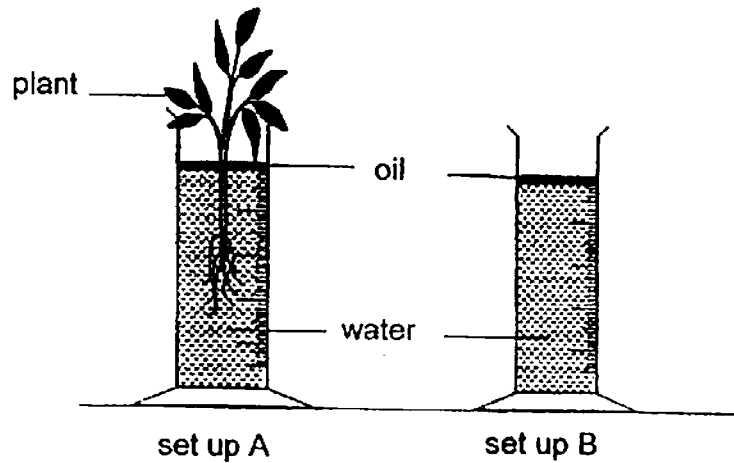

She observed that the water level in set up A dropped while the water level in set up B remained the same.

What can she conclude from this experiment?

- (1) The roots had taken in the water.
- (2) The oil is lost to the surroundings.
- (3) The leaves had absorbed the water.
- (4) The water is lost to the surroundings.

7. The diagram below shows plant R growing on the trunk of a tree and plant S growing around a pole.

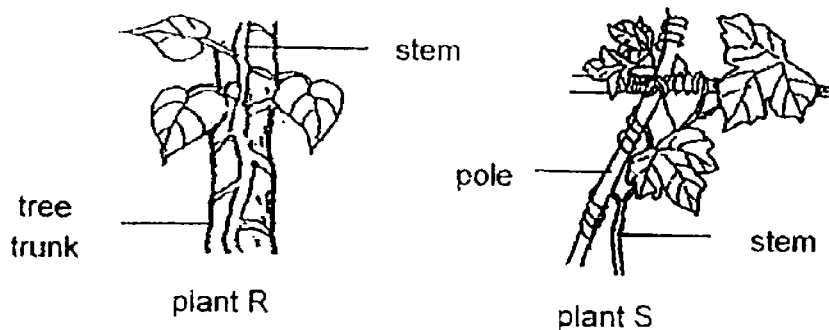

Which one of the following explains why the stem of plant R and plant S grow in this manner?

- (1) Both have broad stems to make more food for the plant.
- (2) Both have broad stems to transport more water and food.
- (3) Both have weak stems to twirl around the tree trunk or pole.
- (4) Both have weak stems and need support to get more sunlight.

8. Jane had to classify the four animals given below.



parrot



bat



frog

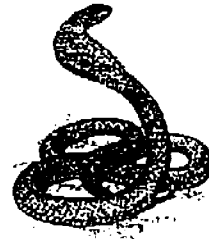

snake

She classified them with the help of the chart below.

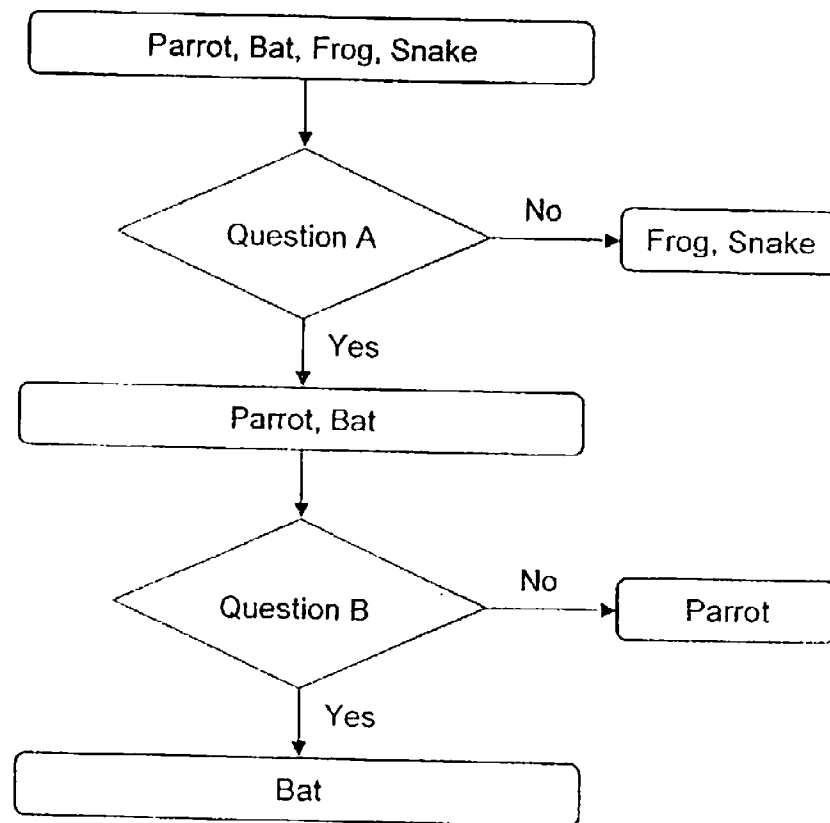

Which one of the following best represents questions, A and B?

	Question A	Question B
(1)	Can they fly?	Do they lay eggs?
(2)	Do they have wings?	Do they lay eggs?
(3)	Can they fly?	Do they have hair / fur?
(4)	Do they have wings?	Do they have feathers?

9. Study the diagram given below.

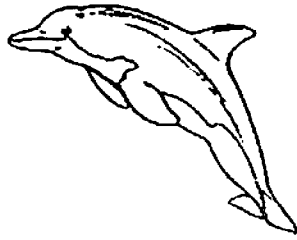

dolphin

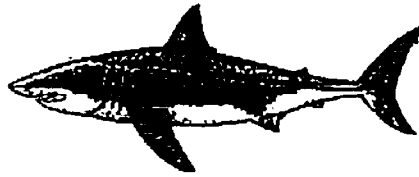

shark

Based only on what is observable in the diagram above, how is the dolphin similar to the shark?

- A Both have tails.
- B Both breathe through lungs.
- C Both give birth to their young alive.
- D Both their bodies are broader in the middle.

- (1) A and D only
- (2) B and C only
- (3) A, C and D only
- (4) B, C and D only

10. Which one of the following is an insect?

(1)

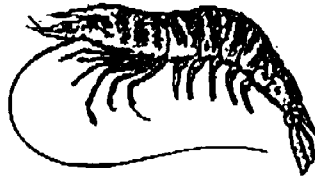

(2)

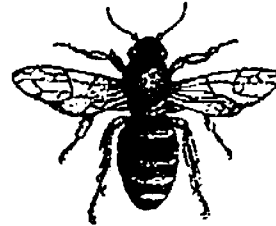

(3)



(4)



11. The diagram below shows the human digestive system.

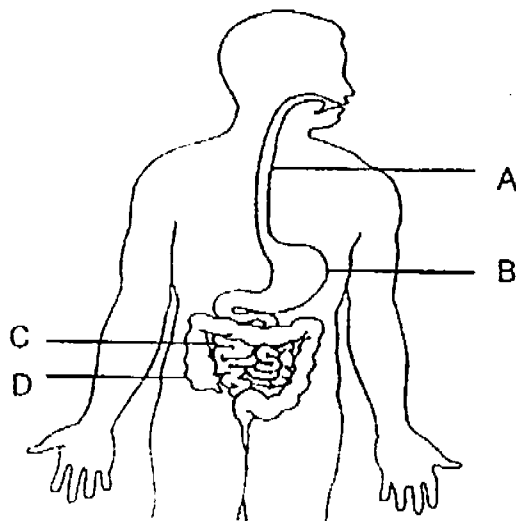

In which of the above parts, A, B, C and D, does digestion not take place?

- (1) A and B
- (2) A and D
- (3) B and C
- (4) C and D

12. Which one of the following is **not** matter?

- (1) soil
- (2) pencil
- (3) shadow
- (4) oxygen

13. Which one of the following substances has a definite shape?

- (1) oil
- (2) air
- (3) water
- (4) marble

14. An ice cream has been left on a plate in the kitchen as shown below.



Which of the following correctly shows the change(s) that would take place in the ice cream after 10 minutes?

	Change in state	Change in shape	Heat gain
(1)	yes	yes	no
(2)	yes	yes	yes
(3)	no	no	yes
(4)	no	yes	no

15. A cup with a hole in the bottom is inverted and placed into a basin of cold water. Which one of the following shows the correct water level in the cup?

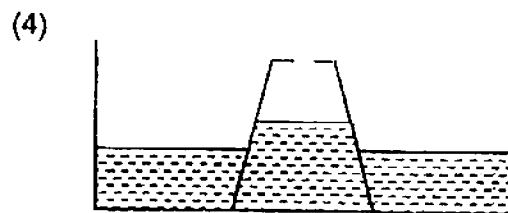
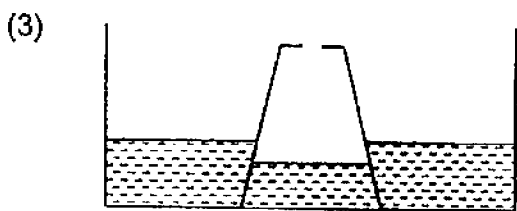
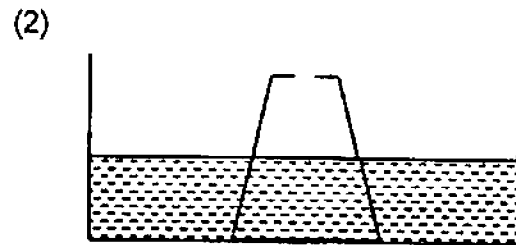
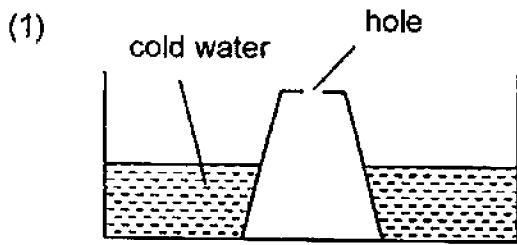

16. Pam suspended three identical magnets from a fixed surface using similar rubber bands, E, F and G. She then placed objects, P, Q and R, below the magnets as shown in the diagram below.

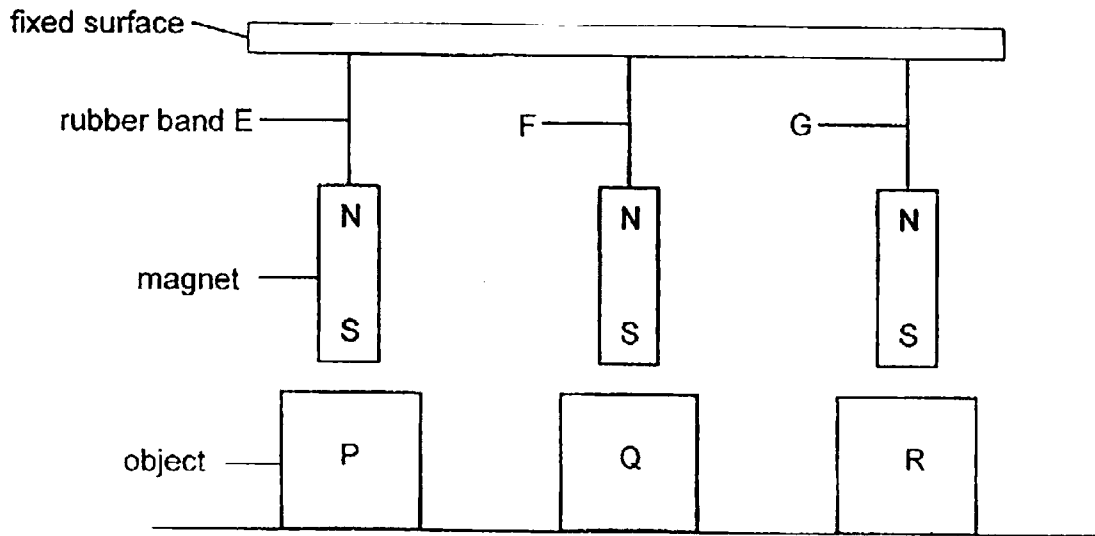

She recorded the lengths of the rubber bands in the table below.

Rubber Band	Length of the Rubber Band (cm)	
	Before object was placed	After object was placed
E	3	1.5
F	3	3
G	3	5.5

Based only on the information given in the table above, which one of the following statements is true?

- (1) Object R repels the magnet.
- (2) Object P attracts the magnet.
- (3) Object Q is made from a non-magnetic material.
- (4) The magnet suspended from rubber band F has the greatest magnetic strength.

17. An iron nail becomes an electromagnet when it is placed in a coil of wire connected to battery / batteries.

Sandra wants to find out if the number of turns of the coil around an iron nail would affect the strength of the electromagnet. Which two set ups should she choose to conduct a fair test?

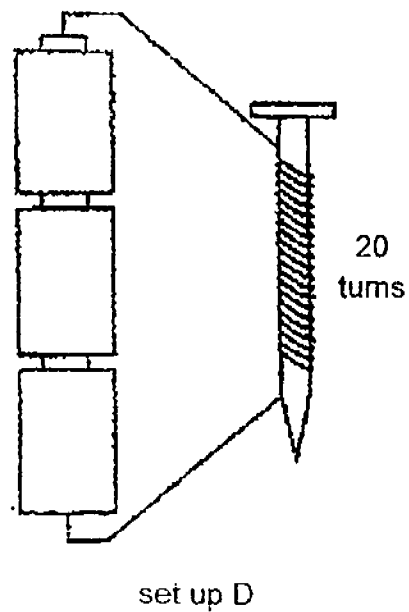
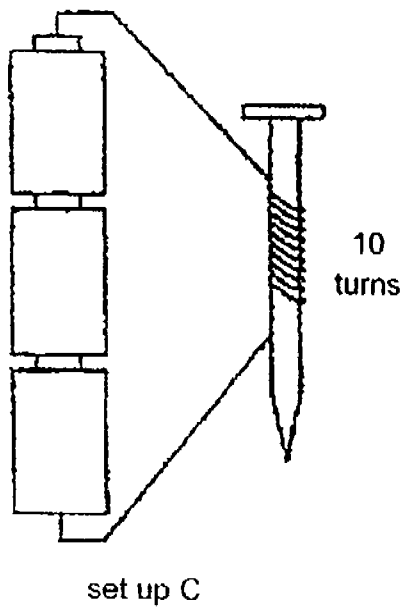
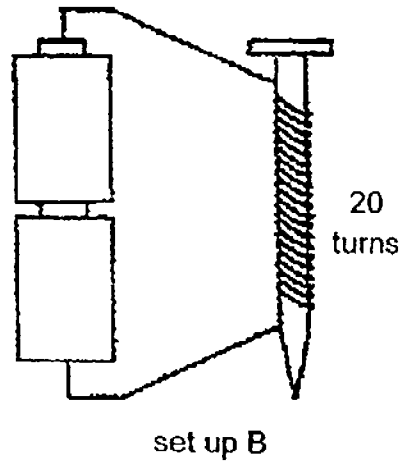
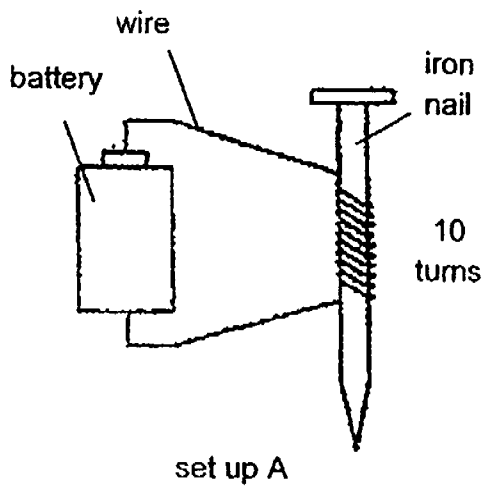

- (1) set up A and set up B
- (2) set up B and set up C
- (3) set up C and set up D
- (4) set up A and set up D

18. In which one of the following will the two magnets attract each other?

(1)



(2)

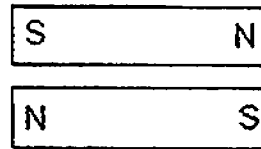

(3)

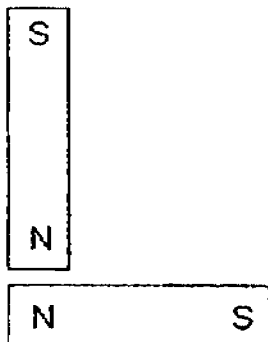

(4)

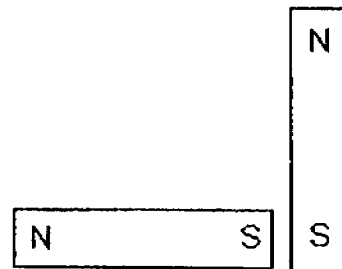

19. Sandra had three objects as shown below.

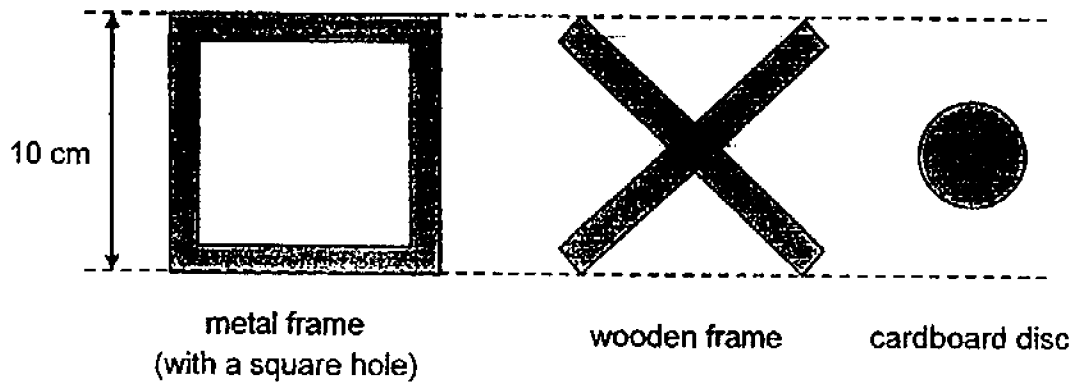

All three objects were placed in the same order as above, at positions A, B and C, respectively as shown in the diagram below. A torch was then used to cast a shadow on a smooth wall.

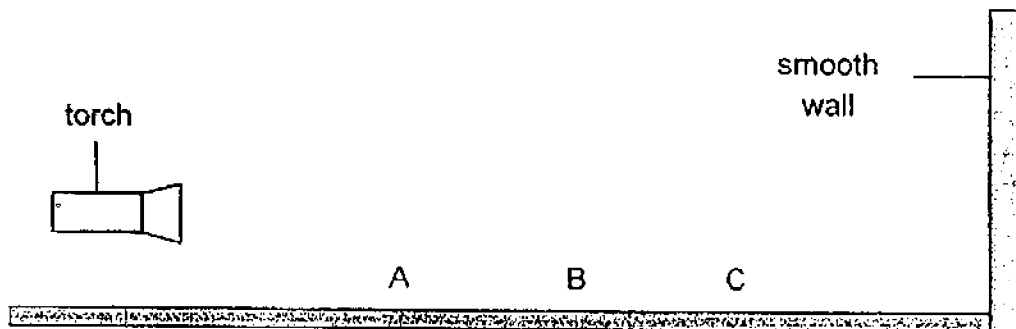

Which one of the following is the most likely shadow cast on the smooth wall?

(1)



(2)



(3)



(4)

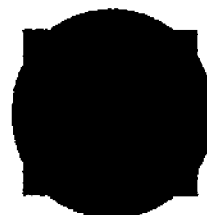

20. Joan wanted to conduct an experiment to find out the amount of light that can pass through different materials of the same size and thickness. They were placed at positions, A, B and C, in a dark room as shown below.

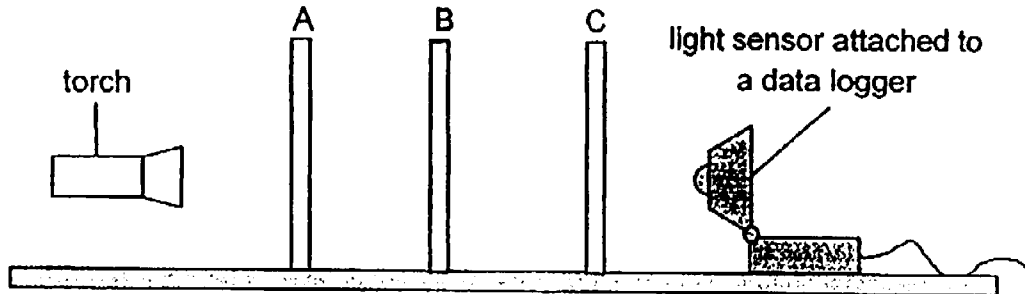

Which one of the following best represents the materials at positions, A, B and C, as shown above?

	A	B	C	Reading on Light Sensor (units)
(1)	tracing paper	wooden plate	clear glass	0
(2)	frosted glass	clear glass	wooden plate	25
(3)	clear glass	clear plastic sheet	frosted glass	0
(4)	wooden plate	clear glass	cardboard sheet	125

21. Zack and Brian were standing at different positions as shown in the diagrams below.
Which one of the following arrangement of mirrors would allow them to see each other clearly?

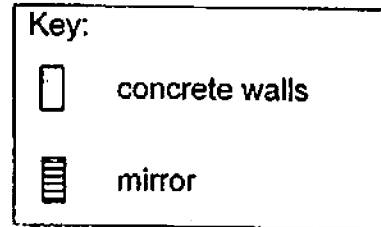

(1)

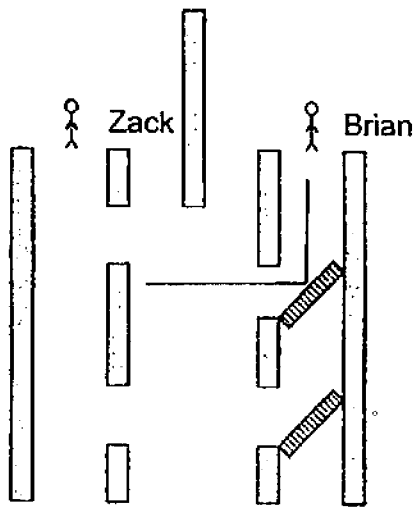

(2)

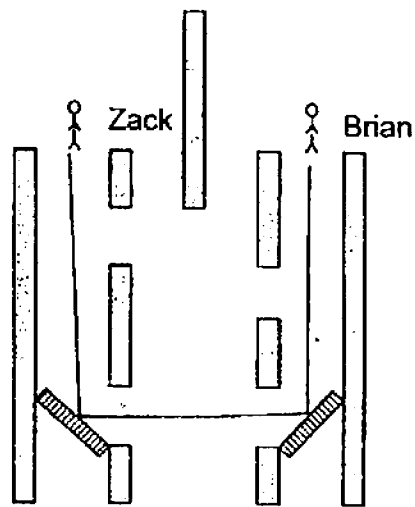

(3)

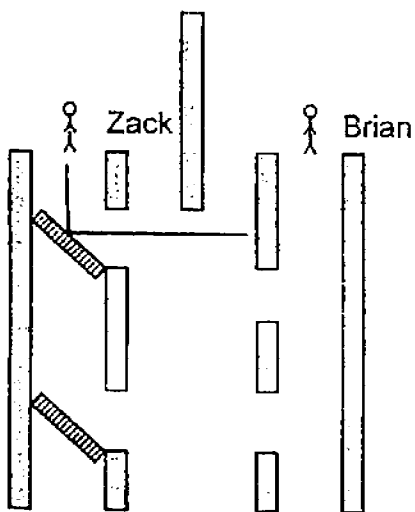

(4)

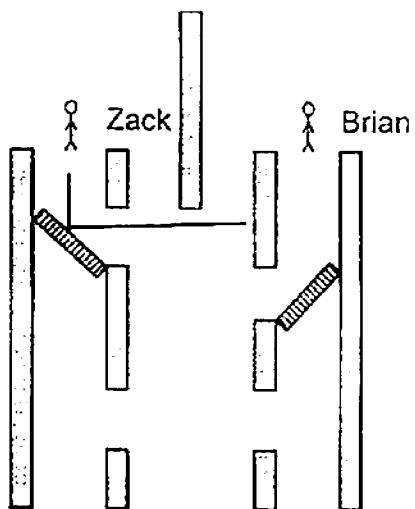

22. Which one of the following is not a source of light?

(1)

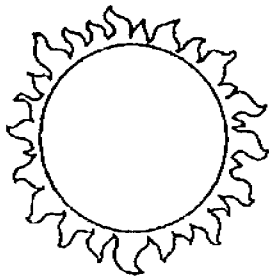

the Sun

(2)

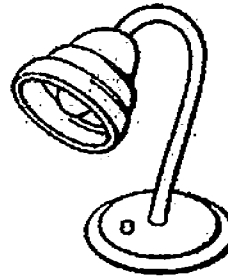

electric night lamp

(3)



fire

(4)



yellow highlighter

23. A pair of metal chopsticks is placed in a bowl of hot soup as shown below.

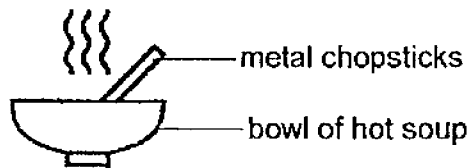

After five minutes, the chopsticks become _____.

- (1) cooler because the bowl loses heat to the hot soup
- (2) cooler because the chopsticks lose heat to the hot soup
- (3) hotter because the chopsticks gain heat from the hot soup
- (4) hotter because the hot soup gains heat from the chopsticks

24. The diagram below shows a cooking pot.

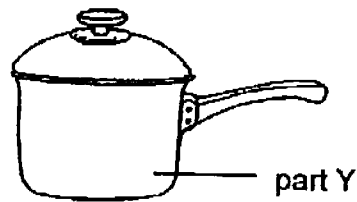

Which of the following shows the property of the material used to make part Y and its function?

	Part Y	Function
(1)	Poor conductor of heat	It does not allow heat to pass through easily.
(2)	Good conductor of heat	It is shiny and can reflect light.
(3)	Poor conductor of heat	It allows the hot water in the pot to cool down faster.
(4)	Good conductor of heat	It allows the hot water in the pot to boil faster.

25. A plastic ruler is attached to a copper wire and a lit candle is placed under the copper wire as shown in the diagram below.

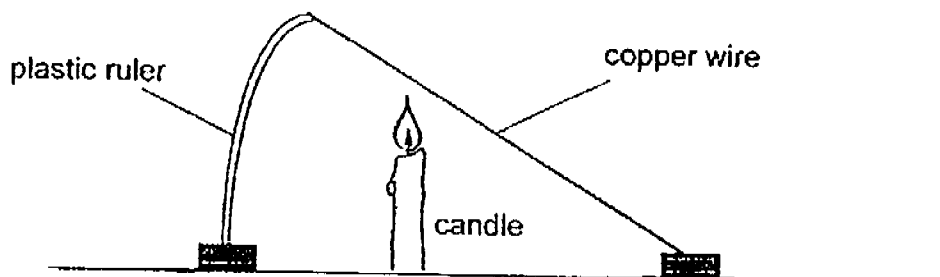

Which one of the following is the most likely observation after ten minutes?

- (1) The copper wire breaks.
- (2) The plastic ruler bends less.
- (3) The plastic ruler bends more.
- (4) The copper wire becomes shorter.

26. Mary took out a piece of meat from the freezer and left it on a plate to defrost.

Which one of the following would take place?

- (1) The plate does not gain or lose any heat.
- (2) The plate gains heat from the piece of meat.
- (3) The piece of meat loses coldness to the plate and the surroundings.
- (4) The piece of meat gains heat from the plate and the surroundings.

27. Two beakers, R and S, were filled with 100 ml and 200 ml of tap water respectively. Both beakers were heated continuously and the temperatures of the water were recorded every five minutes and plotted in a line graph.

Which one of the following graphs best represents the change in temperature for both beakers, R and S?

(1)

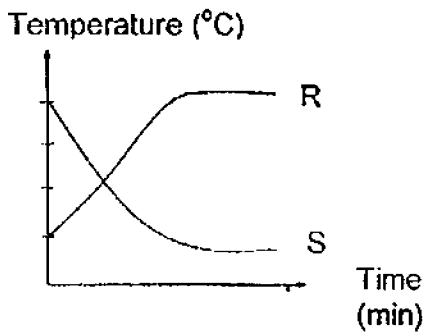

(2)

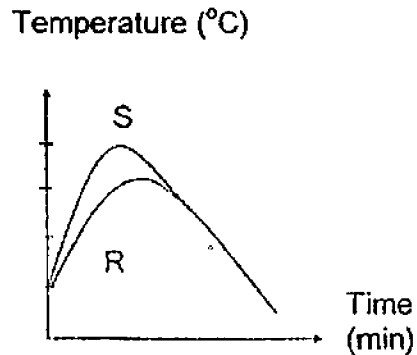

(3)

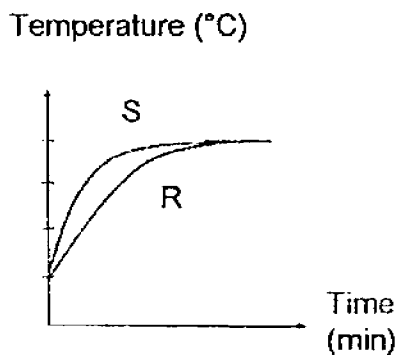

(4)

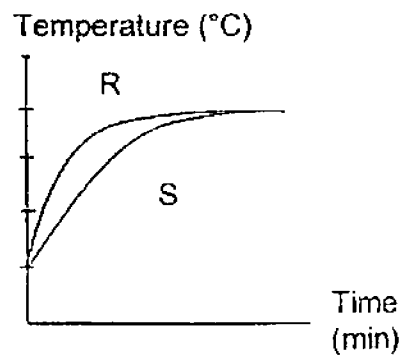

28. The diagram below shows a painting hanging on a wall.

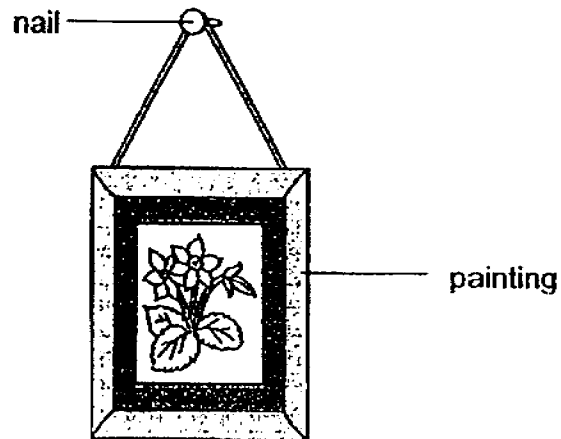

Steel is used to make nails because steel is _____.

- (1) a good conductor of heat
- (2) shiny and will reflect light
- (3) strong and able to hold the painting
- (4) flexible and able to hold the painting

Name : _____ ()

Class : Primary 4 _____

Primary 4
Semestral Assessment 2 – 2016
SCIENCE

BOOKLET B

27 October 2016

Total Time for Booklets A and B: 1 hour 45 minutes

13 questions
44 marks

Do not open this booklet until you are told to do so.
Follow all instructions carefully.
Answer all questions.

This paper consists of 17 printed pages.

Booklet A	56
Booklet B	44
Total	100

Parent's Signature/Date

Section B (44 marks)

For questions 29 to 41, write your answers in this booklet.

The number of marks available is shown in the brackets at the end of each question or part question.

29. The line graph below shows the mass of a butterfly during the 4 stages of its life cycle.

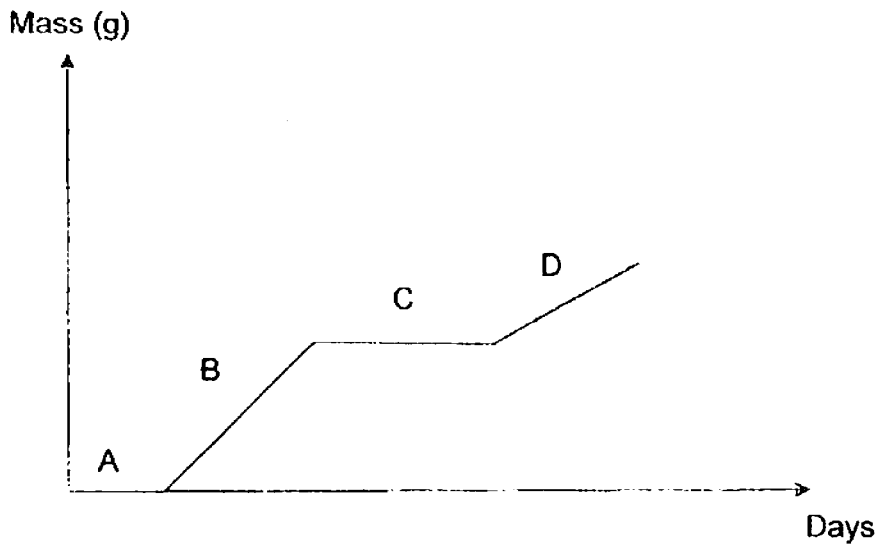

- (a) Explain why the mass remains the same at stage C. [1]

- (b) At which stage of its life cycle is the butterfly considered a pest to the farmers? [2]
Explain your answer.



30. Kelly conducted an experiment on the germination of seeds using the set ups shown below. She placed three similar seeds in each of the two identical glass jars, A and B, lined with an equal amount of damp cotton wool. Jar A was wrapped with a piece of black cloth while Jar B was not. Both set ups were left in the garden.

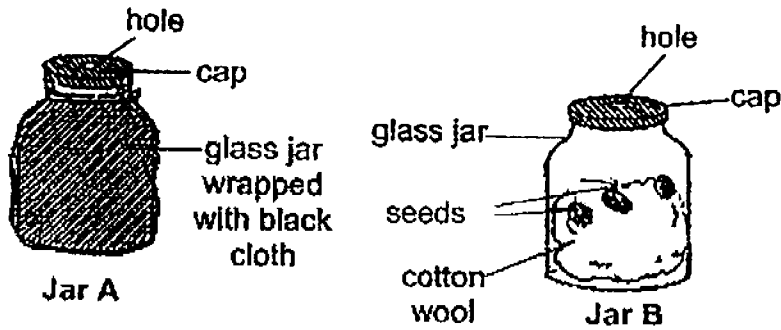

- (a) What was Kelly trying to find out in her experiment? [1]

- (b) In which of these jars, A or B, would the seeds germinate? Explain your answer. [2]



31. Study the flowchart given below.

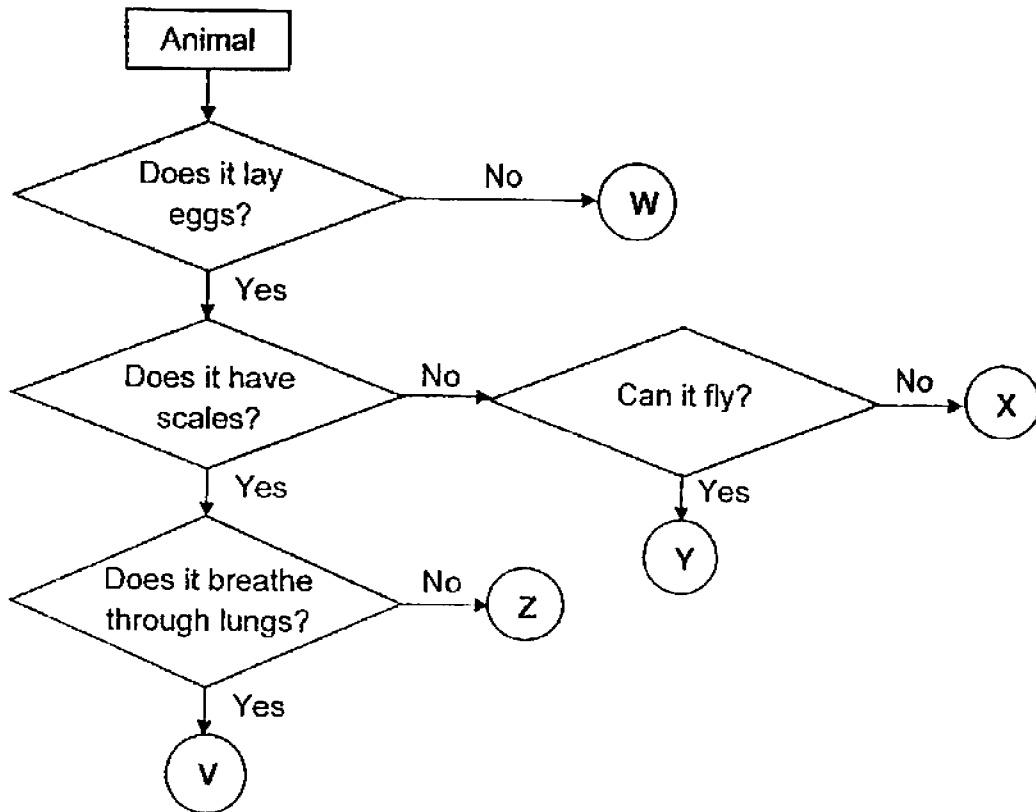

(a) Based on the flowchart above, state one similarity and one difference between X and V. [2]

Similarity : _____

Difference: _____

(b) Based on the flowchart above, which of the above letters, V, W, X, Y or Z, best represents the animals shown below? (Write only the letters.) [2]

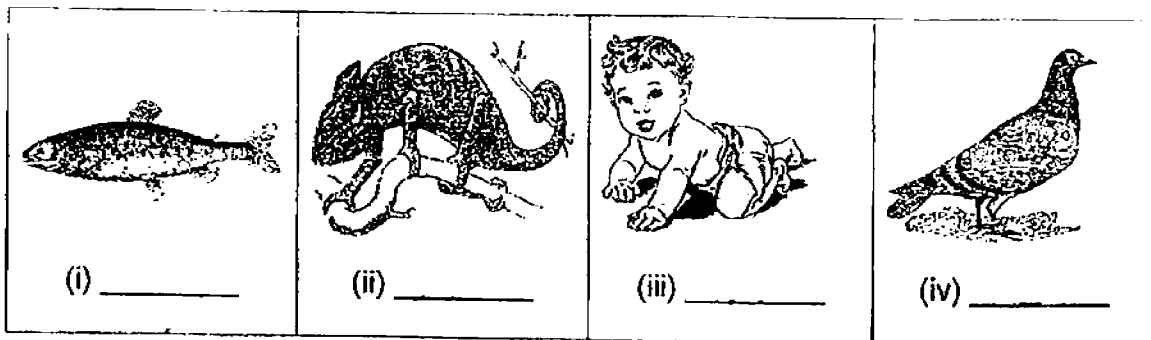

32. John ate a bar of chocolate. The table below shows the amount of digested and undigested food found in different parts of his digestive system as the food passed through them.

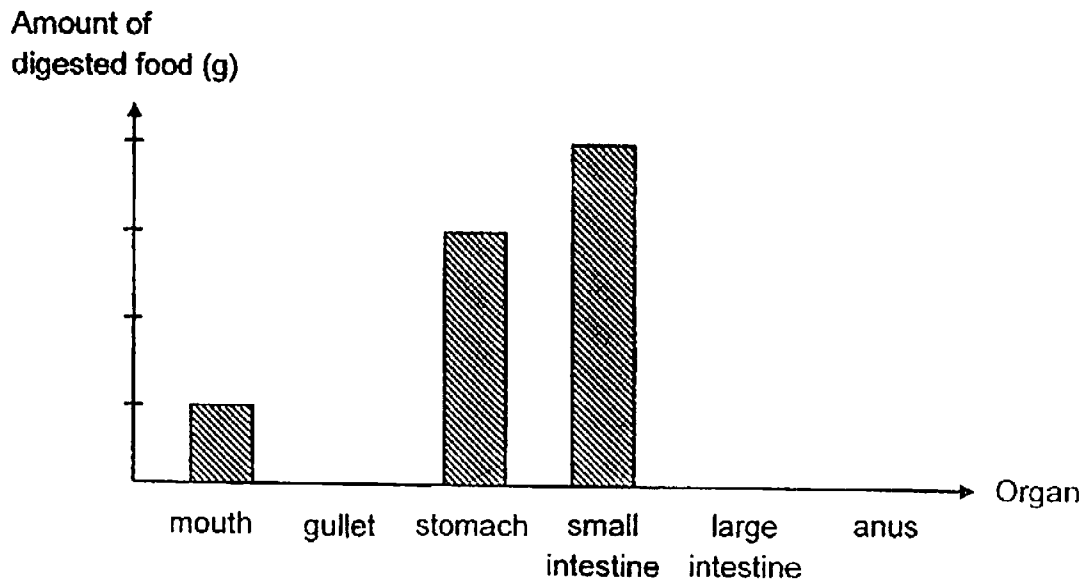

- (a) Complete the graph above by drawing the bar for the amount of digested food in the gullet. [1]

- (b) What will happen to the undigested food if the large intestine is not functioning properly? [1]

- (c) State the function of the human digestive system. [1]



33. Alex placed two objects, P and Q, made of different materials into a beaker of water as shown below.

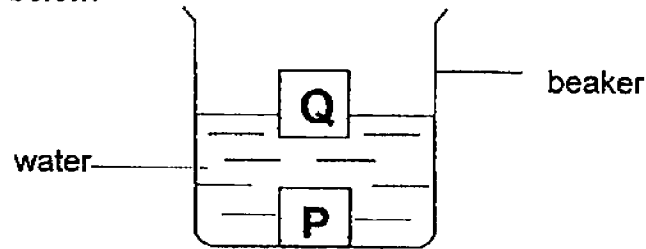

- (a) Based on the diagram shown above, which of the following materials best represent objects, P and Q? (Write the **letter** only). [1]

Styrofoam: _____

Metal : _____

- (b) Give a reason for your answer in (a). [1]

Alex wanted to build a toy sail boat for a race as shown below.

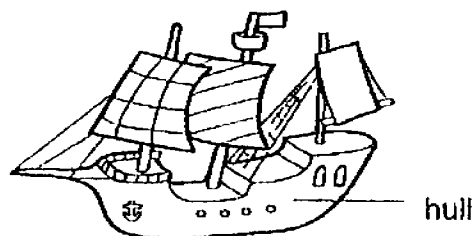

Materials given

styrofoam, ceramic and fabric

- (c) Using the materials given above, state the material that is most suitable for making the hull of the toy sailboat. Give a reason for your answer. [2]



34. The diagram below shows a bowl of hot soup.

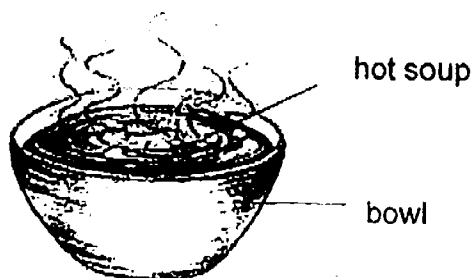

(a) Write the correct state of matter for the following parts. [2]

Bowl : _____

Hot soup : _____

Susan noticed that her mum poked two holes through the lid of the can of milk as shown in the diagram below.

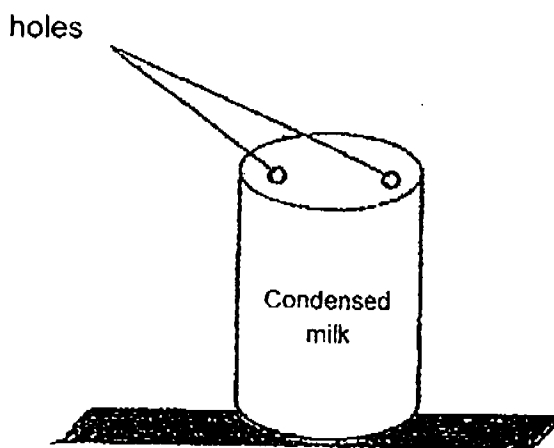

(b) She observed that the milk was flowing out very fast. Explain why having two holes instead of one makes the milk flow out faster. [1]



35. Jimmy conducted an experiment to demonstrate a property of matter. There are two syringes, P and Q. Syringe P contains 50 cm^3 of air while syringe Q contains 50 cm^3 of water.

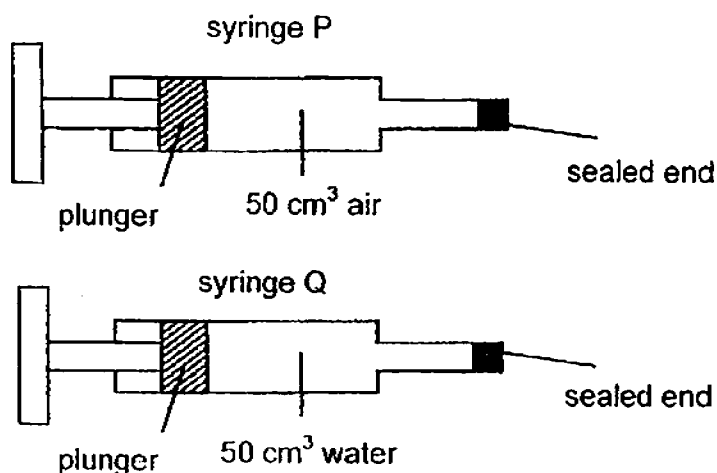

The ends of both syringes are sealed and the plungers are pushed in. He observed both syringes to see if there were any changes to the volume of air and water in the syringes. The results are shown in the graph below.

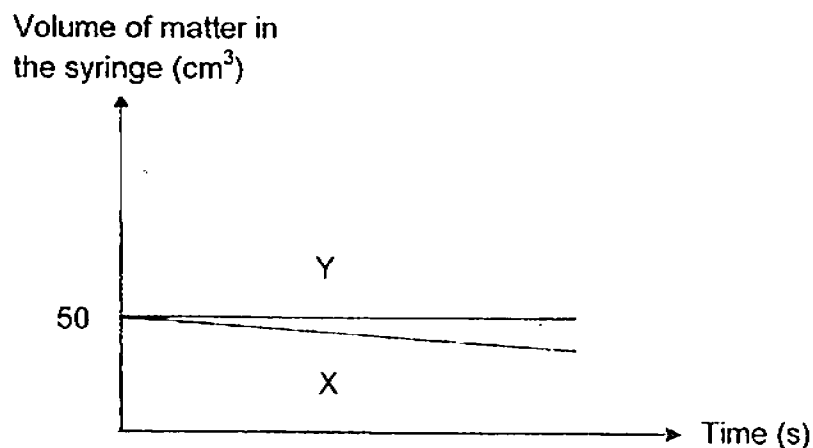

- (a) Based on the results of the experiment, identify which line, X or Y, best represents syringe, P and Q. (Write the **letter** only). [1]

Syringe P: Line _____

Syringe Q: Line _____

- (b) Give a reason for your observation for line X in (a). [1]



Jimmy conducted another experiment using the set up shown below.

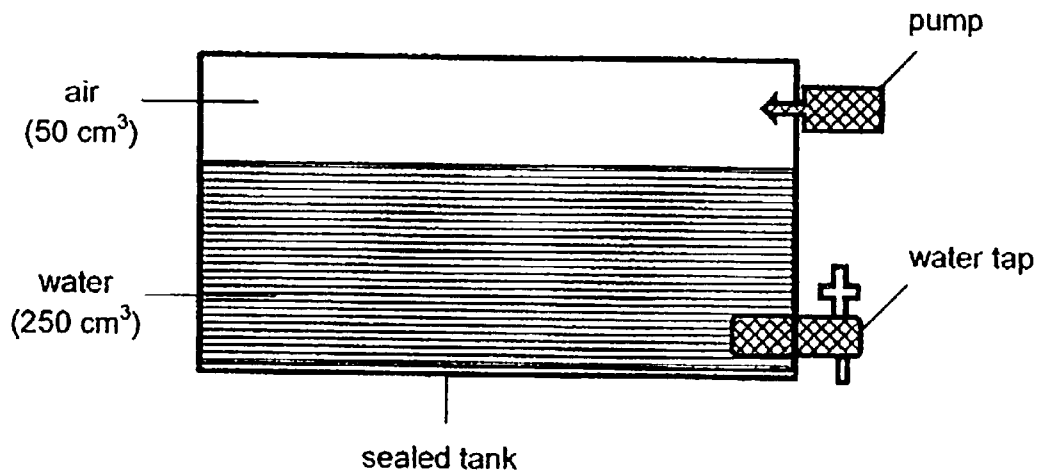

- (c) He used the tap to remove 50 cm^3 of water. He then used the pump to add 40 cm^3 of air into the container.

In the table below, write down the volume of air and water in the sealed tank. [1]

	Volume at Start(cm^3)	Volume at End (cm^3)
air	50	
water	250	

- (d) Give a reason for your answer in (c). [1]



36. Steve bought four magnets of different sizes, E, F, G and H, shown below. All four magnets are of the same height.

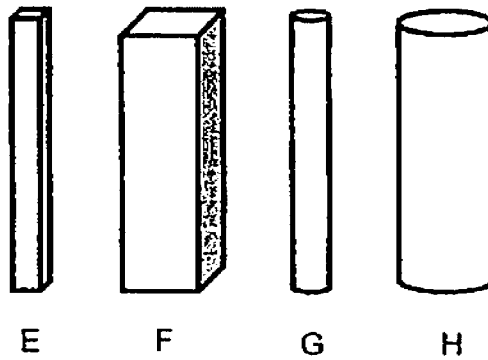

In order to find out if the size of a magnet affects its magnetic strength, he placed each of the magnets near some iron nails.

He then recorded the results in a table as shown below.

Magnet	Distance between magnet and iron nails (cm)	Number of iron nails attracted to the magnet
E	10	20
F	10	30
G	10	30
H	10	20

- (a) Based on this experiment, what can he conclude about the size of the magnet and its magnetic strength?

[1]



He conducted another experiment using four similar magnets, P, Q, R and S, to find out if the distance between the magnet and iron nails affects its magnetic strength. He then recorded the results in a table as shown below.

Magnet	Distance between magnet and iron nails (cm)	Number of iron nails attracted to the magnet
P	9	40
Q	3	40
R	12	40
S	7	40

- (b) Based only on the results given in the table above, state which magnet, P, Q, R or S, has the greatest magnetic strength? Give a reason for your answer. [1]

Steve then stroked two similar iron rods, X and Y, with the same magnet as shown in the diagram below.

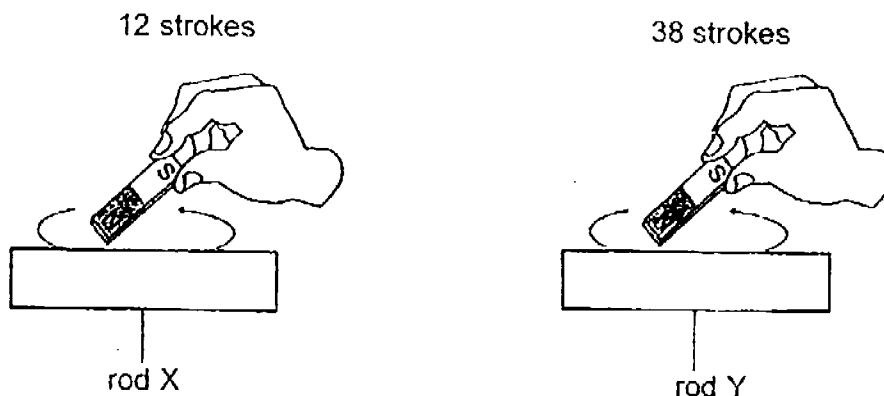

Both rods became magnets and were used to attract similar iron pins. Circle the correct answer below.

[1]

- (c) Rod Y attracted 'less pins than' / 'the same number of pins as' / 'more pins than' rod X.

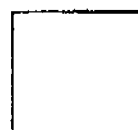

37. The table below shows how objects, P, Q, R and S, interact with each other when moved towards each other.

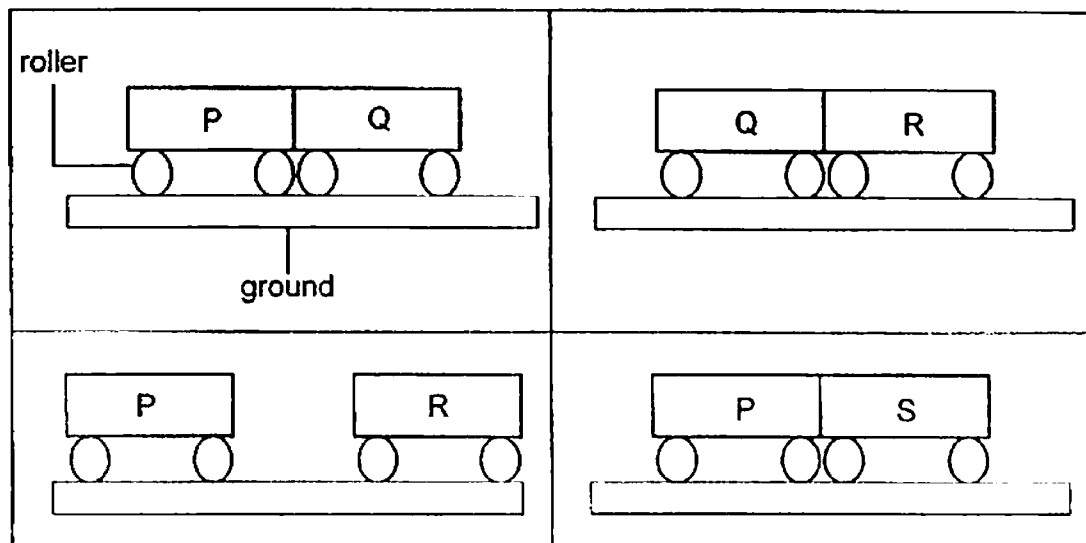

- (a) Based on the interactions between the four objects shown above, state which two objects are magnets. [1]

- (b) Give a reason for your answer in (a). [1]

- (c) Two magnets are placed together as shown below.

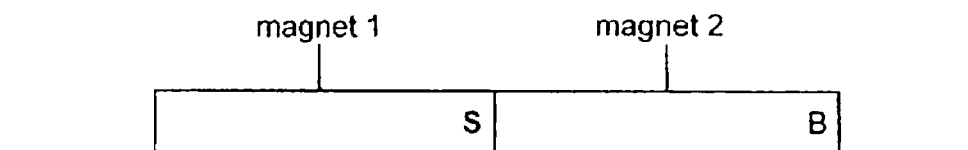

The south pole of magnet 1 is labelled S. Name the poles labelled A and B on magnet 2. [1]

A: _____ Pole

B: _____ Pole



38. Tom carried out an experiment in a dark room using the set up as shown below. He arranged two sheets, X and Y, made of different materials in a straight line. When the torch was switched on, a dim patch of light was seen on the wall.

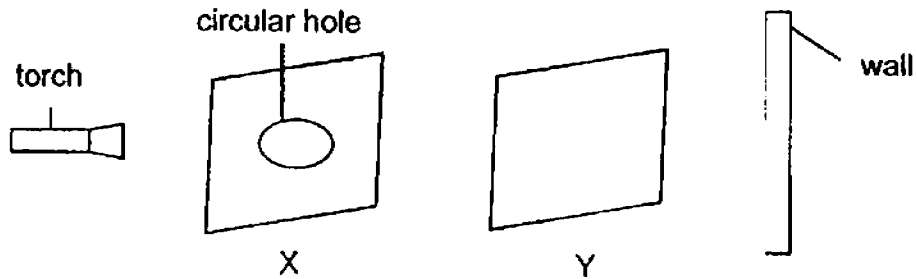

- (a) Based on Tom's observation, state the property of sheet Y in terms of its transparency. [1]

Tom then removed both sheets, X and Y, and replaced it with a ball as shown below. He then shone a torch on the ball and a shadow was formed on the wall.

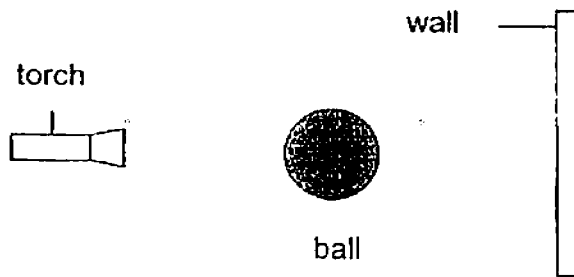

- (b) A shadow is formed when light which travels in a straight line, is _____ by an object. [1]

- (c) Draw and shade the shadow of the ball that is formed on the wall. [1]

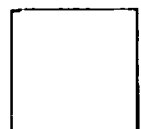
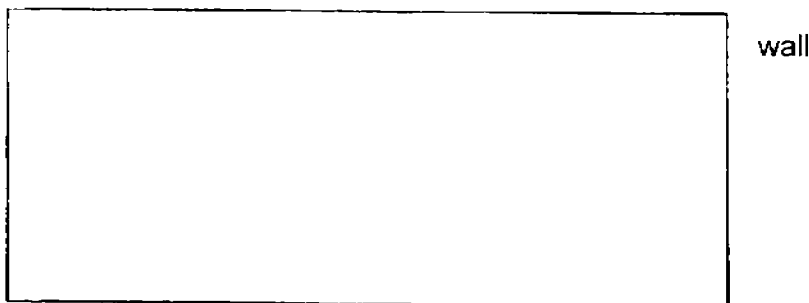

39. Jamal conducted an experiment to measure the amount of light reflected by four different materials, P, Q, R and S, from a light source. He set up his experiment as shown below.

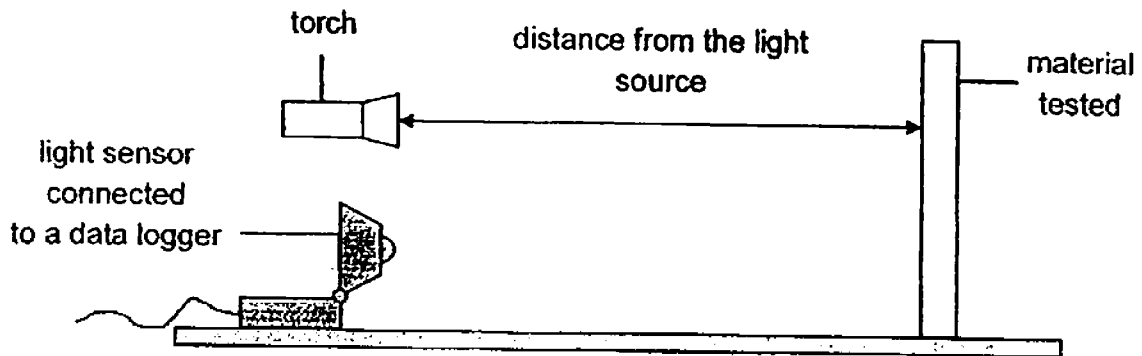

He placed each material at the same distance away from the torch. A light sensor connected to a data logger was used to determine the amount of light that was reflected off the material.

The results of this experiment were recorded as shown in the bar graph below.

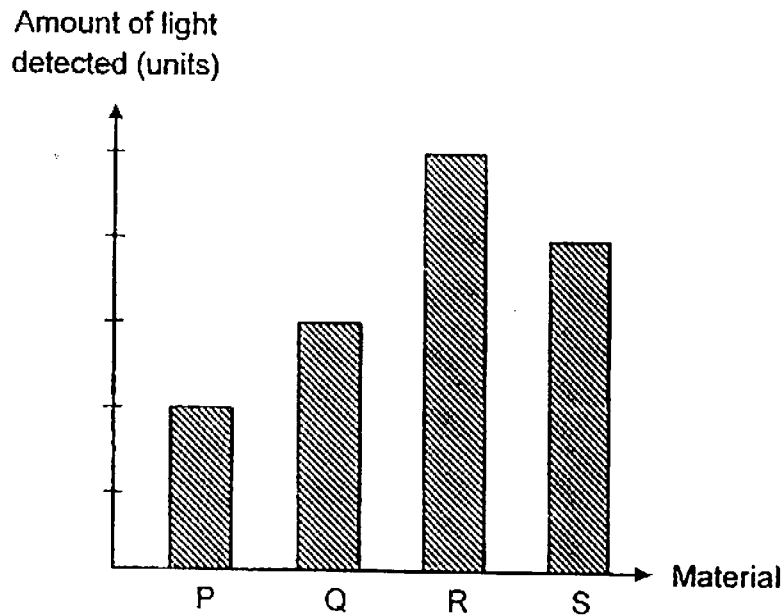

- (a) State the property of light that is shown in this experiment.

[1]



(b) Jamal conducted his experiment in a dark room. Explain how this condition ensures that a fair test is carried out. [1]

(c) State one other variable that should be kept unchanged for this experiment to be a fair test. [1]

The diagram below shows a high visibility vest used by construction workers who work during night time.

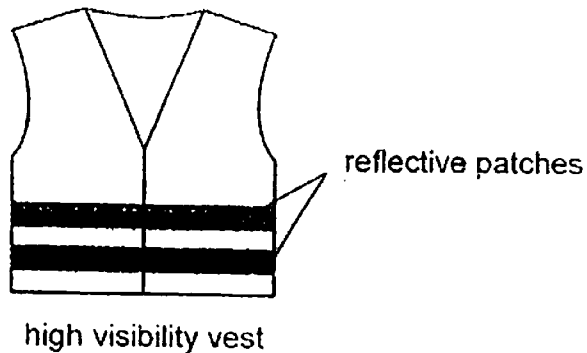

(d) Based only on the results of Jamal's experiment, state which material, P, Q, R or S, would be most suitable for making the reflective patches on the high visibility vest. Give a reason for your answer. [1]



40. James placed two similar rods, made of steel and plastic, into a tank of boiling water for ten minutes as shown below. Equal amounts of wax were placed on both rods.

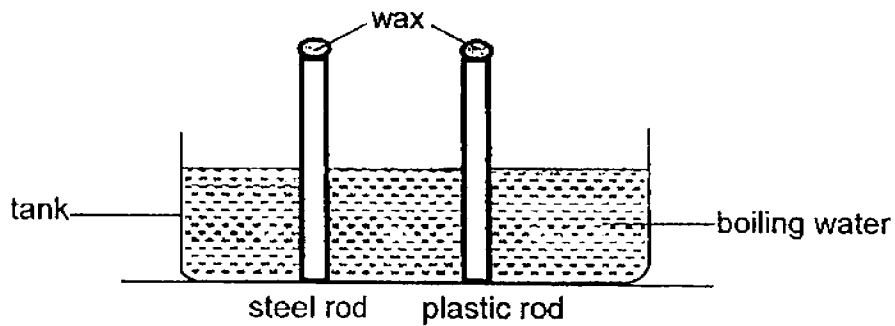

- (a) On which rod, steel or plastic, would the wax melt first? Give a reason for your answer. [2]

In another experiment, James placed four drops of wax at different positions on a rod. A candle was placed at one end of the rod as shown below.

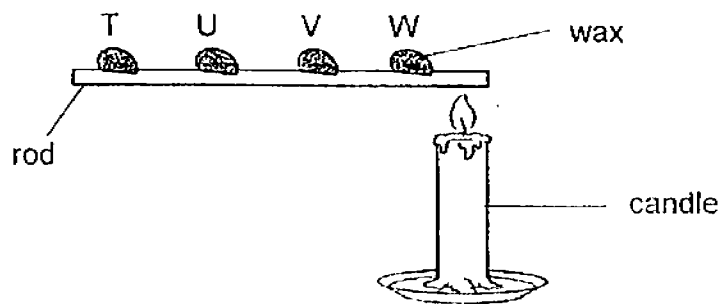

- (b) Arrange the drops of wax, T, U, V and W, in the order that they melted and dropped off, starting with the fastest. [1]

fastest slowest



41. A delivery tube was fitted on a test tube as shown below. It had its other end placed in a beaker of water. When the test tube was heated with a bunsen burner, tiny bubbles could be seen in the beaker of water.

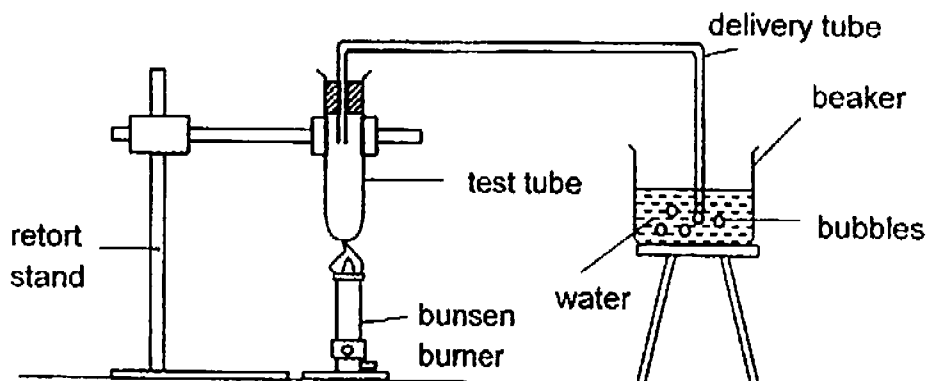

- (a) Explain clearly why bubbles were observed in the beaker of water when the test tube was heated. [2]

- (b) State what could be observed when the bunsen burner was turned off. Give a reason for your answer. [2]



EXAM PAPER 2016 (P4)

SCHOOL : CHIJ

SUBJECT : SCIENCE

TERM : SA2

Q1	Q2	Q3	Q4	Q5	Q6	Q7	Q8	Q9	Q10
3	1	3	1	2	1	4	3	1	2
Q11	Q12	Q13	Q14	Q15	Q16	Q17	Q18	Q19	Q20
2	3	4	2	2	3	3	2	1	1
Q21	Q22	Q23	Q24	Q25	Q26	Q27	Q28		
2	4	3	4	2	4	4	3		

29)a)Stage C is the pupal stage and the pupa does not need to eat or drink as it is in the cocoon.

b)Stage B, the caterpillar stage caterpillar will eat the farmers' harvest and plants.

30)a)Kelly was trying to find out whether sunlight is needed for germination.

b)Seeds in both Jars A and B will germinate. There was air, water and warmth for the germination and sunlight is not needed for germination.

31)a)Similarity : Both X and V lay eggs.

Difference : X does not have scales while V has scales.

b)i)Z ii)V iii)W iv)Y

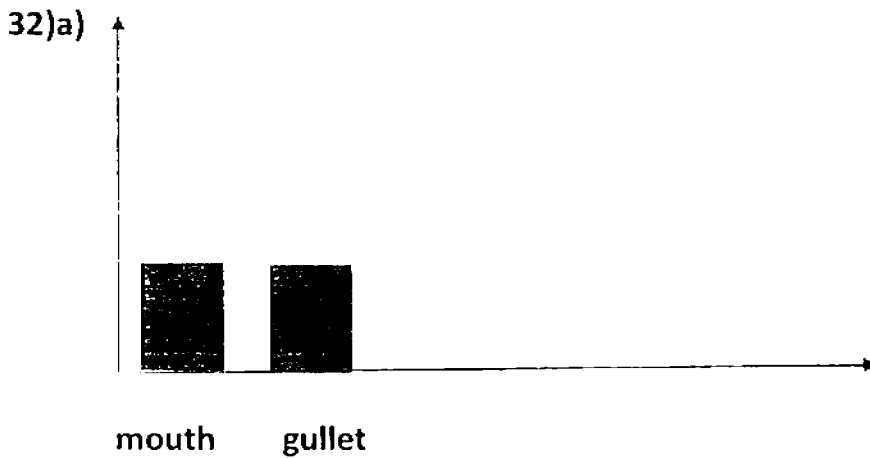

b)The large intestine will not be able to absorb water from the undigested food and the undigested food will be watery when it is passed out of the body.

c)It breaks food into simpler substances and digest food to give energy to the body.

33)a)Styrofoam : Q

Metal : P

b)Styrofoam is light and able to float in water but metal is heavier and able to sink in water.

c)Styrofoam. It is light, waterproof and will not sink in water.

34)a)Bowl : Solid

Hot soup : Liquid

b)Air occupies space and by opening another hole, there will be air entering through one hole that pushes the milk out of the can from another hole.

35)a)Syringe P : Line X

Syringe Q : Line Y

b)Air in syringe P can be compressed and it does not have a definite volume.

c)air : 100

water : 200

35)d)Air in the sealed tank does not have a definite volume and air is able to take up the space which is available after removal of 50cm³ of water and water in the tank has a definite volume.

36)a)The magnetic strength does not depend on the size of the magnet.

b)Magnet R. The distance between magnet R and the iron nails is the furthest even though it attracted the same number of iron nails as other magnets.

c)more pins than

37)a)Objects P and R are magnets.

b)Both objects P and R can attract and repel and only magnets can repel.

c)A: North

B: South

38)a)Sheet Y is translucent and it allows some light to pass through it.

b)blocked

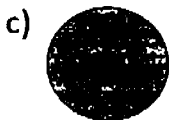

39)a)Light can be reflected by an object and light travels in a straight line.

b)A dark room ensure that any light shining on the material comes only from the torch.

c)The size of the materials.

d)Material R. It reflected the most amount of light and other people can see the construction workers clearly when light is reflected into other people's eyes.

40)a)The steel rod. Steel is a better conductor of heat than plastic and is able to conduct heat faster to the wax.

b)W , V , U , T

41)a)The air in the tested tube gained heat from the bunsen burner and expanded and some of the air moved through the delivery tube and into the beaker, forming bubbles.

b)There were no more bubbles in the beaker. The air in the test tube did not gain more heat and stopped expanding.